



Ages 14+
READ THE INSTRUCTION MANUAL CAREFULLY
PLEASE VISIT WWW.HUBSAN.COM TO UPGRADE



THE HUBSAN X4 BRUSHLESS

ITEM NO.: H501C
ARM/DISARM MOTORS, SEE PAGE 06
RTH FUNCTION, SEE PAGE 09
COMPASS CALIBRATION, SEE PAGE 12
TRANSMITTER CALIBRATION, SEE PAGE 13

COMPASS CALIBRATION BEFORE FLY

Compass calibration is required after the binding as instructed on the transmitter.

- 1.) Rotate the X4 horizontally until the " Set Compass 2" displays on the screen.
- 2.) Put the X4 nose down and rotate it vertically until the " Set Compass 2 " disappears.
- 3.) Calibration done.

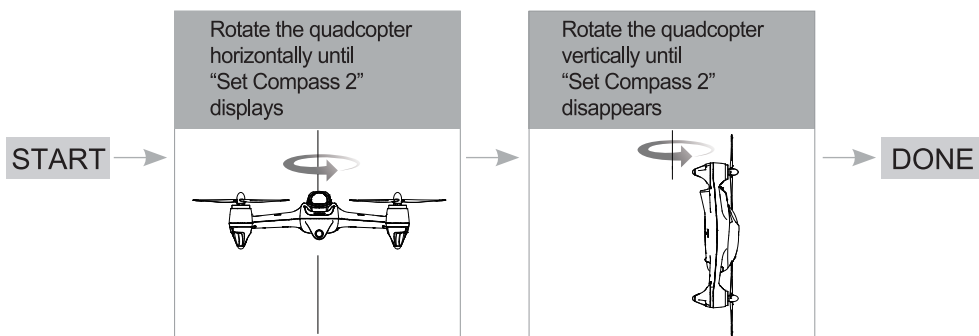

-
- ⊗ Do not calibrate the compass in a strong magnetic field
 - Do not carry ferromagnetic materials with you while calibrating the compass, such as keys, cell phones, etc.
-

Hubsan X4 Brushless

V1.0 2016.05

Please read the instruction manual carefully!

IMPORTANT SAFETY NOTES

OPERATION:

Be extremely careful and responsible when using the drone. Small electronic components can be damaged by crashing or by dropping the X4 into water. To avoid further damages, please replace broken parts immediately.

Flight:

- Take responsibility for the safety of yourself and others when flying the X4!
- Do not fly the X4 in crowded places.
- Do not fly in bad weather.
- Never try to catch the X4 while it is in flight.
- This model is intended for experienced pilots age 14+.
- Power off the X4 after flight, to prevent the propellers from causing injuries.
- Always remove the battery after you stop flying to avoid injuries from accidentally powering on the motors.
- Always take great caution to protect yourself when near the propellers.
The flight system will start after powering on regardless of the transmitter signal. The high speed propellers are very dangerous.
- Power off the X4 after every flight or the propellers may still rotate and cause injury.







INTRODUCTION

Thank you for buying the HUBSAN product. It is designed as an easy-to-use, multi-functional RC model, capable of hovering and acrobatic flight maneuvers. Please read the manual carefully and follow all the instructions. Be sure to keep the manual for future reference.

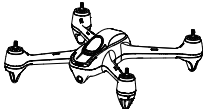
Quadcopter Weight: 435g(including battery)

1. ITEMS INCLUDED IN THE BOX

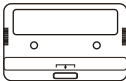
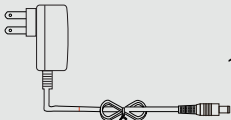
Check all the items in the box before use.

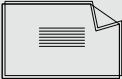
S/N	Part Name	Photos	Q'ty	Remarks
1	Quad copter		1PC	Equipped with smart flight controller,GPS and compass
2	Propellers		8PCS	Propeller A 4pcs, Propeller B 4pcs
3	Transmitter		1PC	Equipped with 4 X AAA battery (Not included)
4	7.4V LiPo battery		1PC	For quad copter
5	LiPo Balance charger		1PC	For recharging the Li-Po battery
6	LiPo Charger Adapter		1PC	110-240V
7	Assistant wrench		1PC	For removing propellers
8	User Manual		2PCS	Disclaimer Hubsan X4 Instruction Manual

2. QUAD COPTER MOTOR LED INDICATOR

Indicator Status:

Front LED: is blue; Back LED: is red.

1. Power on: 4 LED indicators blink simultaneously every 1.5 seconds.
2. Compass Calibration:
 - 1). Horizontal calibration: 4 LED indicators blink circularly.
 - 2). Vertical calibration: 4 LED indicators blink alternately.
3. GPS Flight: 4 LED indicators remain lighted.
4. GPS Return : 2 front LED remain lighted, and 2 back LED blink twice every second.
5. Photo: 2 front LED remain lighted, 2 back LED blink once.
6. Video: 2 front LED remain lighted, 2 back LED blink alternately.
7. LED indicators can be turned off when taking pictures and videos.

3. QUAD COPTER BATTERY

3.1 INTRODUCTION

The quad copter battery is rechargeable with 2700mAh capacity and 7.4V voltage. The battery should ONLY be charged with the HUBSAN charger to avoid overcharge.

3.2 INSTALL THE BATTERY

Push the battery into the battery compartment correctly and connect the battery plugs with the correct polarity.
Close the battery compartment cover.

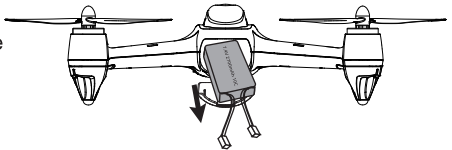

3.3 CHARGING

Connect the battery to the balance charger and wall charger. The balance charger indicator is solid red when charging and turns to solid green when the battery is fully charged. It takes around 210 minutes to get the battery fully charged.

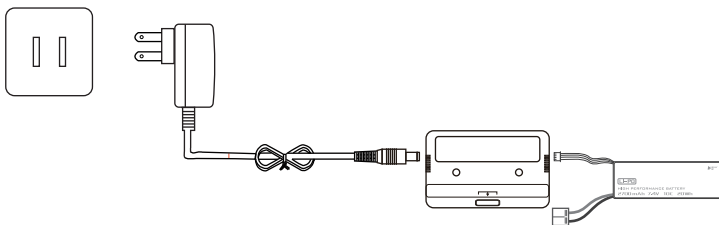

Please fully charge the batteries to avoid loss of control due to low voltage.
Risk of explosion if battery is replaced by an incorrect type.
Dispose of used batteries according to the local regulations.

4. QUAD COPTER UPGRADE

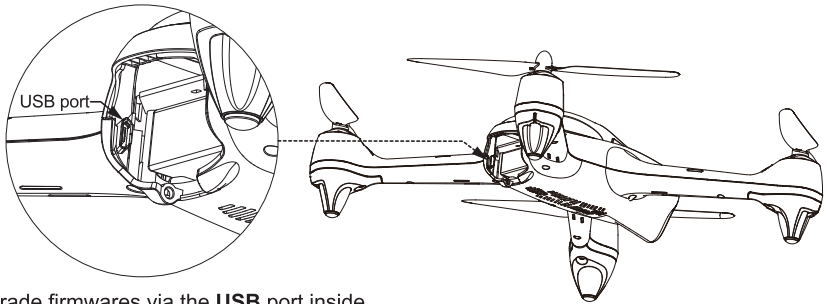

Upgrade firmwares via the **USB** port inside battery compartment.

5. PROPELLER

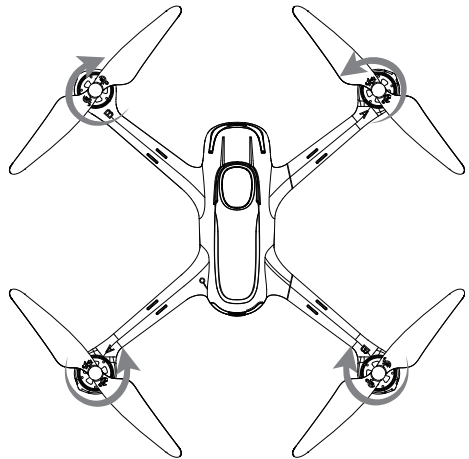
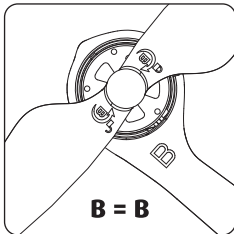
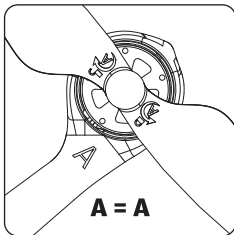

Attach the propellers to the corresponding motors that are marked A and B, tighten the propellers and keep the motors deadlocked with the U wrench.

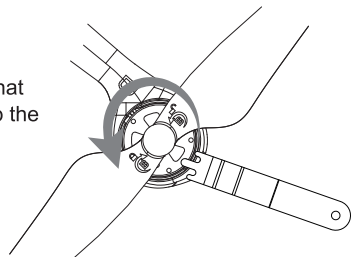

- ⚠️ • Make sure that the A and B propellers are installed correctly. The X4 will not fly if propellers are improperly installed.
- Hazardous moving parts keep fingers and other body part away.

6. START TO FLY

6.1 FLIGHT ENVIRONMENT

- (1) The flying area should be open and without tall buildings or other obstacles; the steel structure within buildings interferes the compass and the GPS signal.
- (2) DO NOT fly in bad weather such as strong wind, heavy snow, rain or fog.
- (3) Keep away from barriers, people, power cables, trees, and other obstructions.
- (4) Do NOT fly near radio towers or airports.
- (5) The X4 control system will not work properly at the South or North Pole
- (6) DO NOT fly in restricted areas and obey your country's laws and regulations.



High Tension Line

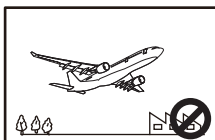

Airport



Interference



Rain

6.2 BINDING

The binding is completed in factory.

For re-binding, press Photo/Video button and power on the transmitter until "H" displayed, then power on the drone, and place it very close to the transmitter, the binding will be completed after one "beep" heard.

Should the binding failed, please power off the drone and repeat above steps.

6.3 ARM/ DISARM THE MOTORS

Arm the motors

Method : Pull the left stick to the left lowest corner and the right stick to the right lowest corner as the picture shows. Release both sticks after the motors are armed.



Disarm the motors







Method : Pull the left stick to the left lowest corner and the right stick to the right lowest corner again, and release both sticks after the motors are disarmed.

⊘ Do not stop the motors during the flight to avoid crashing.

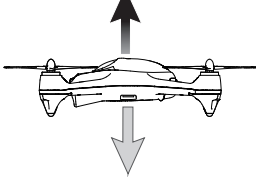
💡 Push the sticks lightly, Release the sticks after the motors are armed or disarmed.

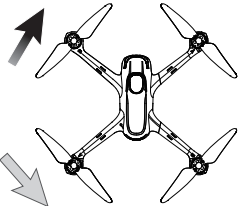
6.4 BASIC FLIGHT

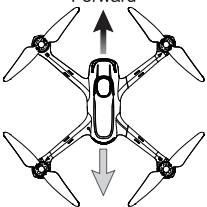
The operation mode for the transmitter including Mode 1 or Mode 2. The manual will use Mode 2 as an example to illustrate the transmitter's operation.

Transmitter (Model 2)	X4	Remarks
	<p style="text-align: center;">UP</p>  <p style="text-align: center;">Down</p>	<p>The throttle stick controls the ascent and descent .</p> <p>Push up the stick and the X4 will ascend.</p> <p>Pull down the stick and the X4 will descend.</p> <p>When the stick is in the center, the X4 will hover and hold its altitude automatically .</p> <p>Move the throttle stick above the center position to take off. (Move the stick slowly to prevent the X4 from ascending too quickly.)</p>
	<p style="text-align: center;">Right rotation</p>  <p style="text-align: center;">Left rotation</p>	<p>The Rudder stick controls the rotate direction .</p> <p>Push the stick left and the X4 will rotate counter-clockwise.</p> <p>Push the stick right and the X4 will rotate clockwise.</p> <p>When the stick is in the center, the X4 will keep the current direction and not rotate.</p> <p>Pushing harder will cause the X4 to rotate faster in the corresponding directions.</p>
	<p style="text-align: center;">Forward</p>  <p style="text-align: center;">Backward</p>	<p>The Elevator stick controls the X4 forward and backward.</p> <p>Push the stick up and the X4 will fly forward.</p> <p>Pull the stick down and the X4 will fly backward.</p> <p>When the stick is in the center, the X4 will hold its position.</p> <p>The angle of stick movement corresponds to the angle of tilt and flight speed.</p>
	 <p style="text-align: center;">Left</p> <p style="text-align: center;">Right</p>	<p>The Aileron stick controls the left and right flight.</p> <p>Push the stick left and the X4 will fly to the left.</p> <p>Push the stick right and the X4 will fly to the right.</p> <p>The X4 should be horizontal and keep the current status when the stick is in the center.</p> <p>The angle of stick movement corresponds to the angle of tilt and flight speed.</p>

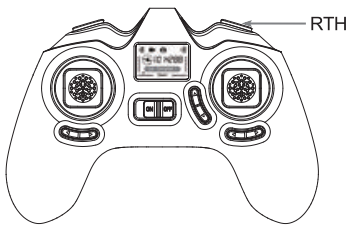

RTH only available when there are no less than 6 GPS satellites displayed on transmitter. Press the RTH for 1.5 seconds to activate the function, press again to stop the RTH.

GPS and RTH function only available outdoors.

6.5 PHOTO / VIDEO

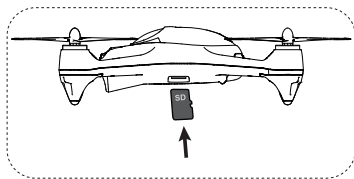
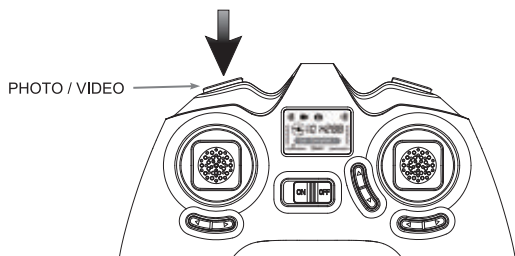

Insert the SD card into quadcopter before using Photo/Video function.

Press the Photo/Video button for 0.5 second to take photos.

Press the Photo/Video button for 1.5 seconds to take videos and press again to save the videos.

 Stop recording before the SD card is removed.

7. ADVANCED PERFORMANCE SETUP

7.1 GPS POSITIONING/ HOME POINT SETTING

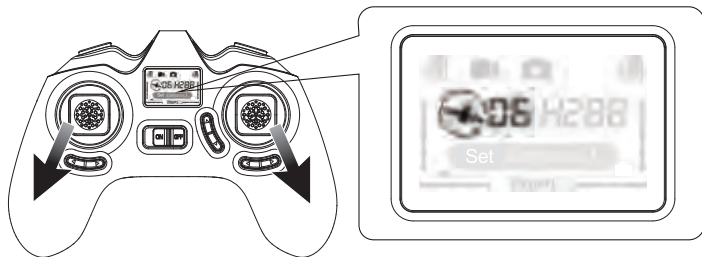



- 1.) GPS Positioning works ONLY when the GPS signal has no less than 6 satellites.
- 2.) Home Point is recorded when armed the motors with no less than 6 GPS satellites.
- 3.) You should be in an open place to search for the GPS satellites, it'll take 3 mins to finish the searching, and the GPS signal strength depends on the flying environment.

7.2 RTH MODE (RETURN TO HOME)

ENTER/ EXIT RTH MODE

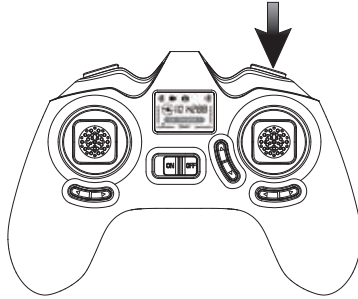
Press the RTH button for 1.5 seconds, and the drone will enter into RTH mode. The flight control system will control the drone to fly back to the home point and land automatically. Press the button again for 1.5 seconds to exit RTH mode.



 The RTH MODE only works when the GPS with no less than 6 satellites.

7.3 FAILSAFE MODE

The drone will enter into Failsafe Mode when the connection is lost from the transmitter. The flight control system will control the quad copter to return to the home point and land automatically. The Failsafe Mode helps to avoid further injuries or damages.

CONDITIONS WHICH ACTIVATE THE FAILSAFE MODE

- (1) Transmitter is powered off.
- (2) The flight distance is beyond the range of the transmitter's signal transmission.
- (3) The transmitter's signal was interrupted by some other strong electronic interference.

-
- ⊙ To ensure that the X4 can return safely to its home point when GPS signal is lost, fly the X4 in safe flight area.
 - If the quantity of GPS satellites drops below six for more than 20 seconds while the X4 is returning home, the X4 will descend automatically.
 - The X4 will not avoid obstacles automatically while in failsafe mode. You must set the height value to avoid obstacles in the flight path.
-

8. TRANSMITTER

Interface

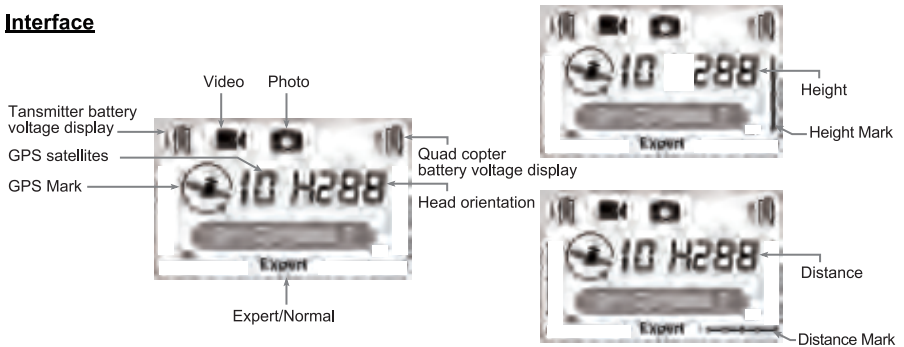

Transmitter

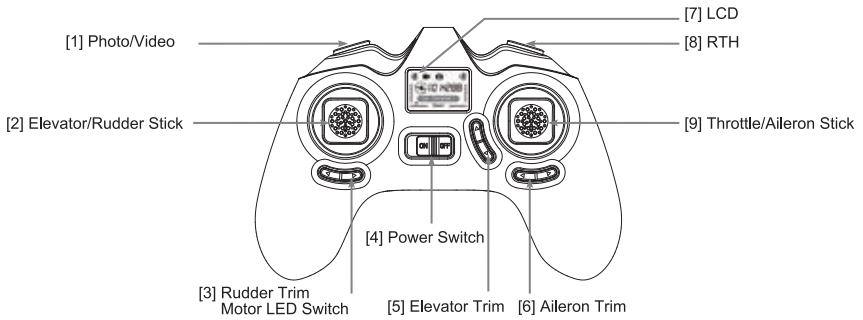

MODE 1

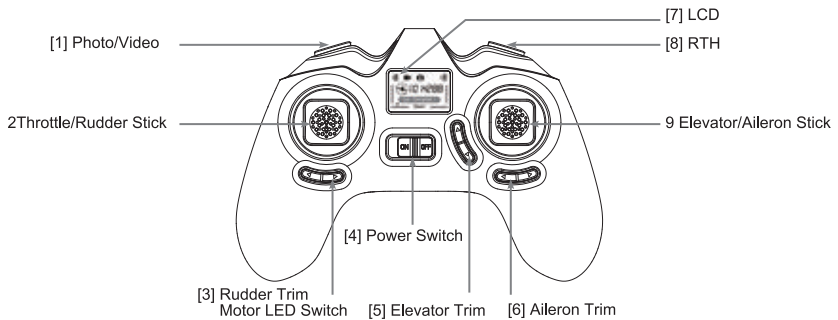

MODE 2

8.1 INSTALL THE TX BATTERY

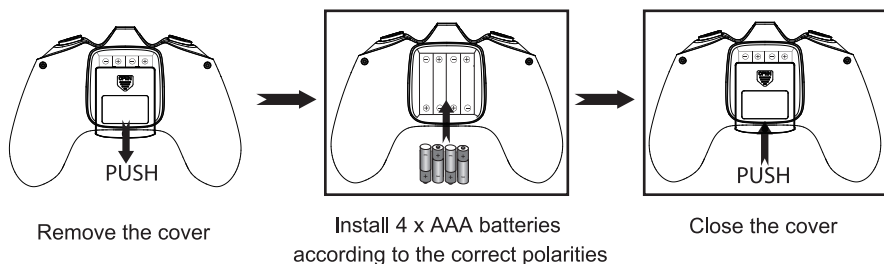

- Do not mix old and new batteries
- Do not mix different types of batteries
- Do not charge non-rechargeable battery.

8.2 NORMAL AND EXPERT FLIGHT MODES

The default setting for X4 is Normal Mode, and the Expert Mode can be activated to have a better sensitivity on the performance of the X4.

Press the Elevator stick 0.5 second to shift between Normal Mode and Expert Mode, indicated by one “beep”. When it enters into Expert Mode, “Expert” will be displayed on LCD.

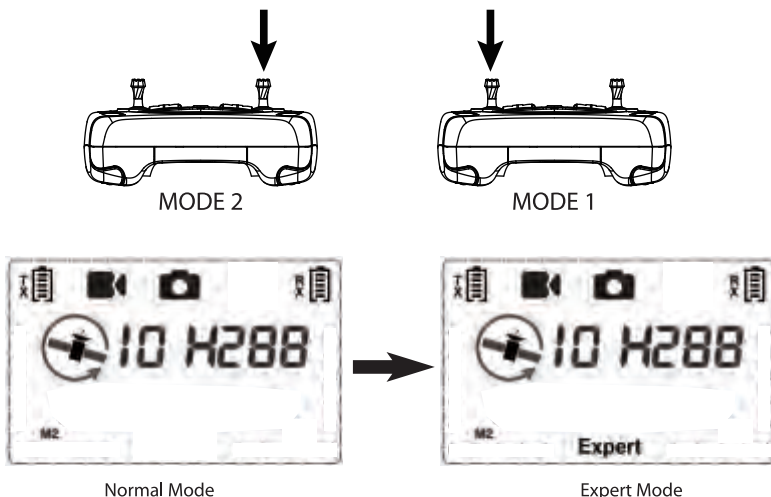

Notice:

1. If the batteries in the transmitter runs low while flying the X4, you can still control the X4, please land the X4 and then replace batteries in the transmitter.
2. Please only use 4XAAA batteries or NI-MH AAA batteries in case of any damages to the transmitter.

9. COMPASS CALIBRATION

Compass calibration is required before the first time flight, otherwise the system may not work properly. The compass is very sensitive to electromagnetic interference which can cause abnormal compass data and lead to poor flight performance or even flight failure. Regular calibration enables the compass is in optimum performance.

- ⊗ Do not calibrate the compass in a strong magnetic field.
- Do not carry ferromagnetic materials with you while calibrating the compass, such as keys, cell phones, etc.

COMPASS CALIBRATION PROCEDURES

Please follow the calibrating procedures before the first flight.

1.) Hold the Throttle Stick to the far left side, and move the Aileron Stick left to right quickly until the transmitter displays " Set Compass 1" (Mode 2);

Hold the Throttle Stick to the far left side, and move the Aileron Stick left to right quickly until the transmitter displays " Set Compass 1" (Mode 1)

2.) Rotate the X4 horizontally clock-wise until the LCD screen displays " Set Compass 2"

3.) Put the X4 nose down and rotate it vertically counter clock-wise until the " Set Compass 2" on screen disappears

4.) Calibration done.

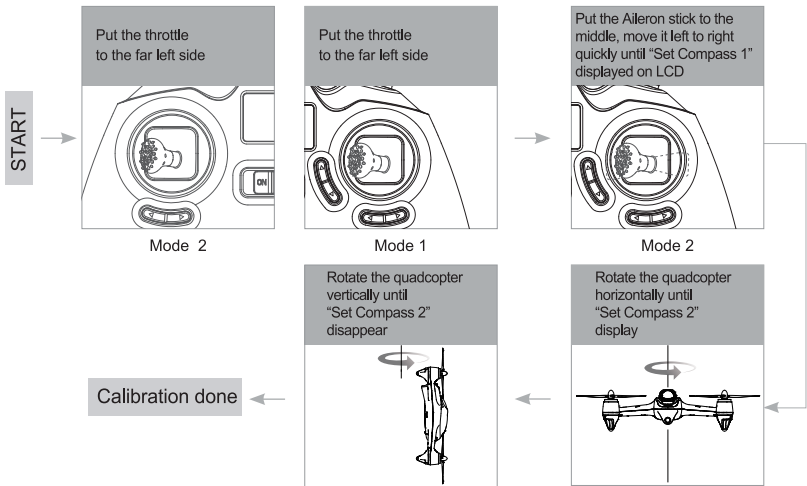

⚠ Flying in the area nearby magnetic field would interfere the compass which need re-calibration as above instructed.

10. TRANSMITTER CALIBRATION

Mode 2: Push both sticks to the upper left corner and power on the transmitter simultaneously. The LCD will display "OH", rotate both sticks in circles three times, release the sticks and press any trim for 1.5 seconds until one "Beep" heard which indicates a successful calibration.

Mode 1: Push the left stick to the upper left corner and right stick to the upper right corner and power on the transmitter simultaneously, The LCD will display "OH", rotate both sticks in circles three times, release the sticks and press any trim for 1.5 seconds until one "Beep" heard which indicates a successful calibration.

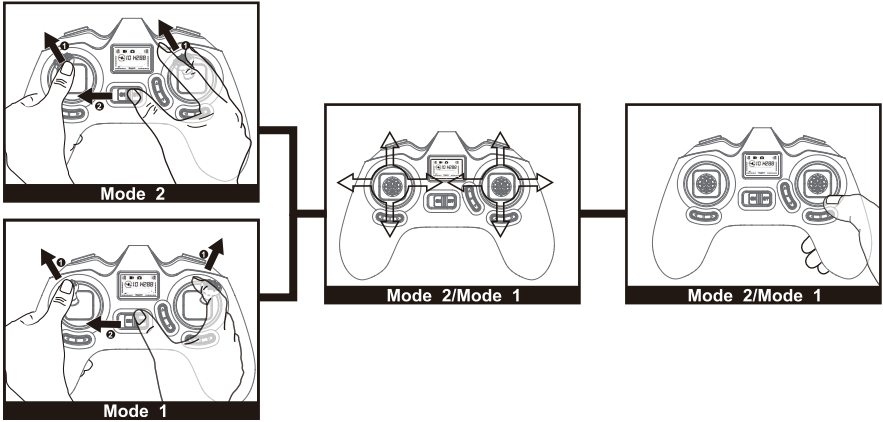

The transmitter mode can be shifted according to the above operation.

EXPLODED VIEW

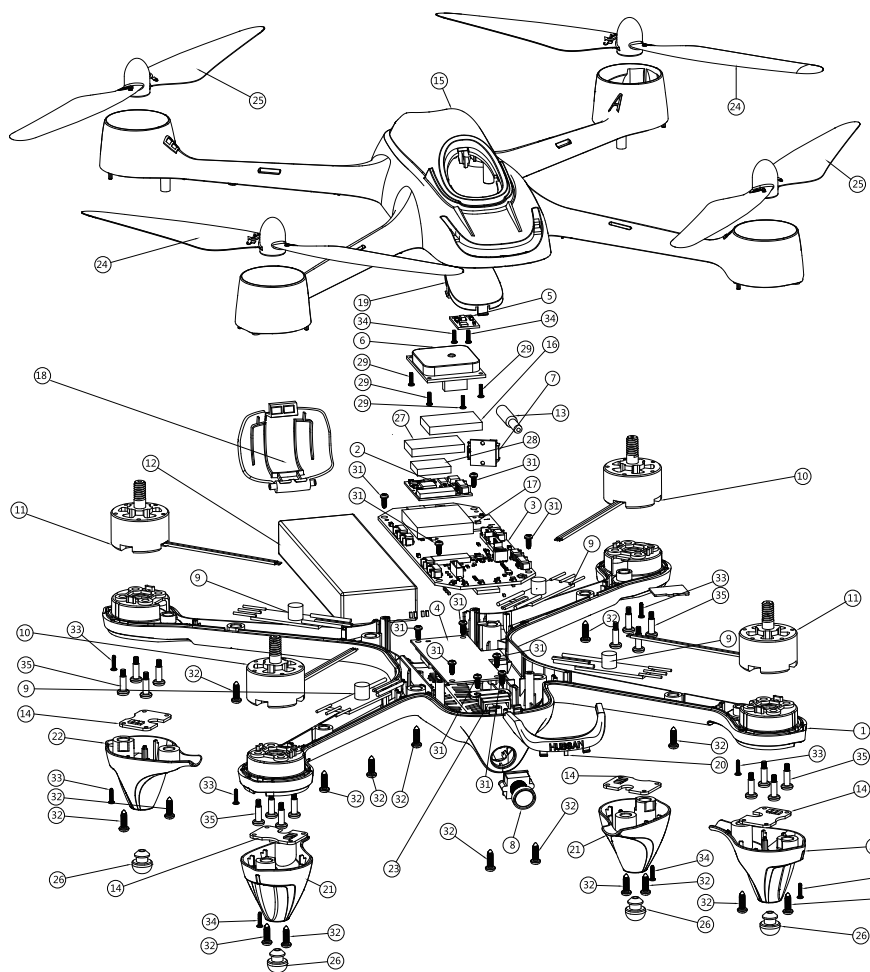

NO.	PART NAME	QTY
01	Lower Body Shell	1
02	Main Control Board	1
03	Power Board	1
04	2.4 GHz Transmission Module	1
05	Compass PCBA	1
06	GPS Module	1
07	USB PCBA	1
08	Camera Module	1
09	ESC	4
10	Motor A	2
11	Motor B	2
12	Li-Po Battery	1
13	2.4G Antenna	1
14	LED PCBA	4
15	Upper Body Shell	1
16	2.4GHz Shielding Case	1
17	Sponge	1

NO.	PART NAME	QTY
18	Battery Cover	1
19	Canopy	1
20	Eye Lampshade	1
21	Motor A Lampshade	2
22	Motor B Lampshade	2
23	Lens Holder	1
24	Propeller A	2
25	Propeller B	2
26	Rubber Feet	4
27	Shielding Case	1
28	Sponge	1
29	Screw	4
30	Screw	10
31	Screw	16
32	Screw	8
33	Screw	2
34	Screw	16

H501C SPARE PART CHART



H501C-01
Body Shell Set



H501C-02
Battery Cover



H501C-03
Eye Lampshade



H501C-04
Canopy



H501C-05
Lamp Base A/B

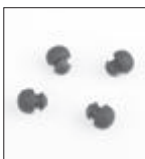

H109-04
Rubber Feet



H501S-04
Screw Set



H501C-06
Propeller A



H501C-07
Propeller B



H501C-08
Brushless Motor A



H501C-09
Brushless Motor B

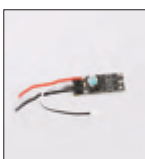

H501S-19
A ESC

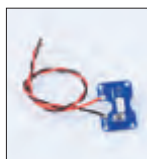

H501C-10
LED Kit



H501S-09
PCB Module

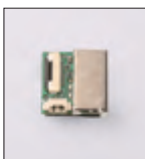

H501S-10
Flight Control PCB Module



H501S-21
2.4G Receiver Module



H501C-11
1080P Camera Module

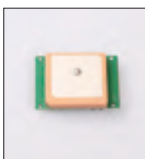

H501S-12
GPS Module

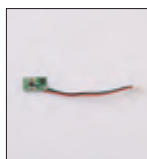

H501S-13
Compass Module



H501C-14
Battery



H502E-07
TX H907A Remote



H301S-11
Adapter



H301S-12
Balance Charger



H501S-16
U Wrench

FCC INFORMATION

This equipment has been tested and found to comply with the limits for a Class B digital device, pursuant to Part 15 of the FCC Rules. These limits are designed to provide reasonable protection against harmful interference in a residential installation. This equipment generates, uses, and can radiate radio frequency energy and, if not installed and used in accordance with the instructions, may cause harmful interference to radio communications. However, there is no guarantee that interference will not occur in a particular installation. If this equipment does cause harmful interference to radio or television reception, which can be determined by turning the equipment off and on, the user is encouraged to try to correct the interference by one or more of the following measures:

- Reorient or relocate the receiving antenna.
- Increase the separation between the equipment and receiver.
- Connect the equipment into an outlet on a circuit different from that to which the receiver is connected.
- Consult the local dealer or an experienced radio/TV technician for help.

Changes or modifications not expressly approved by the party responsible for compliance could void the user's authority to operate the equipment.

This device complies with Part 15 of the FCC Rules. Operation is subject to the following two conditions: (1) this device may not cause harmful interference, and (2) this device must accept any interference received, including interference that may cause undesired operation.

ENVIRONMENTALLY FRIENDLY DISPOSAL

Old electrical appliances must not be disposed of together with the residual waste, but have to be disposed of separately. The disposal at the communal collecting point via private persons is for free.

The owner of old appliances is responsible to bring the appliances to these collecting points or to similar collection points. With this little personal effort, you contribute to recycle valuable raw materials and the treatment of toxic substances.



Electrical and electronic equipment that are supplied with batteries (including internal batteries)

WEEE Directive & Product Disposal

At the end of its serviceable life, this product should not be treated as household or general waste. It should be handed over to the applicable collection point for the recycling of electrical and electronic equipment, or returned to the supplier for disposal.

Internal / Supplied Batteries.

This symbol on the battery indicates that the battery is to be collected separately.

This battery is designed for separate collection at an appropriate collection point.



User manual is subject to change without prior notice due to unforeseen product upgrades.

Download the latest user manual from

WWW.HUBSAN.COM

VERSION 1.0 EN

